

illumina Bio-Rad SureCell WTA 3' Library Prep for Peripheral Blood Mononuclear Cells (PBMC)

Demonstrated Protocol



Table of Contents

Chapter 1 Overview	1
Introduction	1
Additional Resources	1
Chapter 2 Protocol	3
Introduction	3
Critical Workflow Steps	4
Tips and Techniques	4
Preliminary Cell Prep Optimization Guidelines	5
Library Prep Workflow	7
Prepare, Count, and Assess Viability of Single-Cell Suspension	8
Prepare Cell and Barcode Suspension Mixes	9
Isolate Single Cells	12
Reverse Transcribe Samples	19
Break Emulsion	20
Clean Up First Strand Synthesis	21
Synthesize Second Strand cDNA	25
Clean Up cDNA	26
Tagment cDNA	29
Amplify Tagmented cDNA	30
Clean Up Libraries	31
Assess Libraries	34
Prepare for Sequencing	35
Appendix A Supporting Information	37
Introduction	37
How does the SureCell WTA 3' Assay Work?	37
Cell Counting Protocol	37
Lab Tracking Chart	39
Acronyms	40
Kit Options	40
Consumables and Equipment	43
Technical Assistance	44

Chapter 1 Overview

Introduction	1
Additional Resources	1

Introduction

This protocol describes how to prepare 3'-tagged RNA-Seq libraries from peripheral blood mononuclear cells (PBMC) for whole transcriptome gene profiling analysis on Illumina sequencing systems. The protocol requires a Bio-Rad ddSEQ Single-Cell Isolator and reagents provided in the Illumina® Bio-Rad® SureCell™ WTA 3' Library Prep Kit for the ddSEQ™ System to isolate single cells and barcode individual transcriptomes.

The SureCell WTA 3' demonstrated protocol for PBMC is optimized for 1000 single cells as output for each ddSEQ Single-Cell Isolator cartridge. Each cartridge has four chambers that can be loaded with up to two unique samples for an average cell output of 500 cells per sample. Typical genic count for PBMCs are ~400 genes per cell. For more information on optimal cell number recommended for tertiary analysis, see the *Single-Cell RNA Sequencing of Peripheral Blood Mononuclear Cells* Technical Note. Libraries generated from this demonstrated protocol have been evaluated on the NextSeq platform. A representative data set can be found on BaseSpace Sequence Hub Public Data. Performance on other Illumina platforms may require additional user optimization.

The SureCell WTA 3' Library Prep Kit for the ddSEQ System protocol includes the following features:

- ▶ Comprehensive workflow for single-cell analysis of 3' RNA transcripts
- ▶ Significant reduction in the time from cell culture to cell lysis using the ddSEQ Single-Cell Isolator for cell isolation
- ▶ Individual droplets have cell lysis, cell barcoding, and unique molecule tagging
- ▶ 15 minute tagmentation process to fragment cDNA and add adapter sequences
- ▶ Benefits of using master mixed reagents, saving reagent containers, pipetting, and hands-on time

Data analysis is conducted using the Illumina SureCell RNA Single-Cell App in the BaseSpace Sequence Hub. The SureCell RNA Single-Cell App performs sample demultiplexing, single-cell identification, genome alignment, 3' gene counting, and cell clustering. The SureCell RNA Single-Cell App supports multiple species, including, but not limited to, human, mouse, and rat genomes.



DISCLAIMER

The information in this Illumina Demonstrated Protocol is being provided as a courtesy. In some cases, reagents are required to be purchased from non-authorized third-party suppliers. Illumina does not guarantee or promise technical support for the performance of our products used with any reagent purchased from a non-authorized third-party supplier.

Additional Resources

Visit the SureCell WTA 3' Library Prep Kit for the ddSEQ System support page on the Illumina website or ddSEQ Single-Cell Isolator page on the Bio-Rad website for documentation, software downloads, training resources, and information about compatible Illumina and Bio-Rad products.

The following documentation is available for download from the Illumina website.

Resource	Description
Custom Protocol Selector	A wizard for generating customized end-to-end documentation that is tailored to the library prep method, run parameters, and analysis method used for the sequencing run.
Consumables and Equipment List (document # 100000021455)	Provides an interactive checklist of user-provided consumables and equipment.

The following documentation is available for download from the Bio-Rad website.

Resource	Description
ddSEQ Single-Cell Isolator Instruction Manual (Document # 10000069430)	Provides instructions for installing and operating the Bio-Rad ddSEQ Single-Cell Isolator.

Chapter 2 Protocol

Introduction	3
Critical Workflow Steps	4
Tips and Techniques	4
Preliminary Cell Prep Optimization Guidelines	5
Library Prep Workflow	7
Prepare, Count, and Assess Viability of Single-Cell Suspension	8
Prepare Cell and Barcode Suspension Mixes	9
Isolate Single Cells	12
Reverse Transcribe Samples	19
Break Emulsion	20
Clean Up First Strand Synthesis	21
Synthesize Second Strand cDNA	25
Clean Up cDNA	26
Tagment cDNA	29
Amplify Tagmented cDNA	30
Clean Up Libraries	31
Assess Libraries	34
Prepare for Sequencing	35

Introduction

This chapter describes the SureCell WTA 3' Library Prep Kit for the ddSEQ System protocol, from cell preparation through qualification and quantification of final libraries for sequencing.

Before you begin, do the following.

- ▶ Review [SureCell Best Practices](#) on the Illumina website.
- ▶ Confirm that [Illumina Experiment Manager v1.13](#) or later is used to set up the sequencing sample sheet if BaseSpace Prep Tab is not used. Version 1.13 or later has the appropriate UMI settings and index sequences for sample demultiplexing.
- ▶ When using BaseSpace Sequence Hub for sequencing analysis, confirm that SureCell RNA Single Cell App v1.2 or later is used.
- ▶ Confirm that [bcl2fastq v2.18](#) or later is used for FASTQ generation.
- ▶ This protocol is verified to process up to four cartridges in one experiment. If this is your first experiment, process 1–2 cartridges. If you are processing more than four cartridges, contact Illumina Tech Support for a modified protocol.
- ▶ Confirm that the ddSEQ Single-Cell Isolator is installed and operating properly.
- ▶ Review pipetting techniques in the ddSEQ Single-Cell Isolator Instruction Manual.
- ▶ Confirm kit contents and make sure that you have the required equipment and consumables. This protocol requires two different magnetic stands during library clean-up procedures. See *Supporting Information* on page 37.
- ▶ Review the color-coded caps that identify the associated suspension mix of the reagents in this protocol.
 - ▶ Red caps identify reagents used to create cell enzyme mix
 - ▶ Blue caps identify reagents used to create barcode suspension mix
- ▶ Use a Lab Tracking Chart to record sample observations throughout the protocol. See *Lab Tracking Chart* on page 39.

Critical Workflow Steps

Several steps within the workflow require additional attention and are key to single-cell library success.

- 1 Filter cells through a cell strainer with sufficient pore size to remove cell clumps.
- 2 Visually confirm that cells are dissociated to single-cell suspension.
- 3 Keep your cell suspensions on ice at all times.
- 4 A bead purification step purifies single-cell DNA from sample wells containing separate oil and aqueous layers. Visually confirm that magnetic beads are well-mixed.
- 5 A custom sequencing primer is provided for Read 1. Dilute the provided primer to the concentration specified for the sequencer you are using.

Tips and Techniques

Unless a safe stopping point is specified in the protocol, proceed immediately to the next step.

Designating Separate Areas

- ▶ Conduct all tissue and cell activities in a designated aseptic area that is restricted to cell culture work.
- ▶ Conduct all pre-PCR activities (cell lysis, tagmentation, and amplification preparation procedures) in a dedicated environment physically separated from amplified genetic material (post-PCR).
- ▶ Do not pass material or equipment from the post-PCR area to the pre-PCR area.
- ▶ Consult your local regulations for universal precautions regarding amplicon control practices and biohazardous material handling.

HUMAN MATERIAL PRECAUTION

Use caution when handling any human cells. Human PBMC should be handled as if capable of transmitting infectious agents. Use universal precautions as recommended by the CDC/NIH manual *Biosafety in Microbiological and Biomedical Laboratories (BMBL) 5th Edition*.

Avoiding Cross-Contamination

- ▶ When adding or transferring samples, change tips between *each sample*.
- ▶ Use aerosol-resistant pipette tips to reduce the risks of reagent carry-over and sample-to-sample cross-contamination.

Sealing the Plate

- ▶ Always seal the 96-well plate before the following steps in the protocol:
 - ▶ Centrifuge steps
 - ▶ Thermal cycling steps
- ▶ Use 8-strip tube caps to seal plates.

Handling Purification (Magnetic) Beads

This protocol does not include excess Purification Beads (SPB) reagent volume for dispensing from a reservoir and discarding excess volume. Use a single-channel pipette to transfer SPB from the reagent tube to individual sample wells.

- ▶ Use beads at room temperature.

- ▶ Vortex immediately before use. Confirm that the beads are well-dispersed and the color appears homogeneous.
- ▶ Pipette accurate bead volume as this is essential to protocol success:
 - ▶ Beads are viscous; pipette beads slowly from stock tube to obtain full volume.
 - ▶ Remove any additional drops collected on the outside of the tip before dispensing to the sample plate.
 - ▶ Dispense beads slowly into the sample plate, allowing time to ensure the entire volume has been dispensed from the pipette tip.
 - ▶ Do not prime pipette tips with bead solution.
- ▶ When washing beads:
 - ▶ Always prepare fresh 80% ethanol for wash steps. Ethanol can absorb water from the air, impacting your results.
 - ▶ Use the specified magnet for the plate.
 - ▶ Dispense liquid so that beads on the side of the wells are wetted.
 - ▶ Keep the plate on the magnet until the instructions specify to remove it.
 - ▶ Do not agitate the plate while on the magnetic stand. Do not disturb the bead pellet.
 - ▶ If beads are aspirated into the pipette tips, dispense them back to the plate on the magnetic stand and wait a few minutes until the liquid is clear.
 - ▶ Do not let the beads dry out unless specified by the protocol.

Preliminary Cell Prep Optimization Guidelines



CAUTION

- ▶ Before starting the protocol, make sure you have the specified cell quantities, consumables, and equipment required to complete the protocol.
- ▶ After cells have been prepared, there are no safe stopping points until *Synthesize Second Strand cDNA* has begun. Proceed immediately to each step in the protocol.
- ▶ Cells must be kept cold on ice at all times but should not be frozen. Do not remove the cells from ice until instructed to do so during *Isolate Single Cells* on page 12.

The following attributes are critical for the success of the SureCell WTA 3' assay.

- ▶ **PBMC source**—This protocol has been developed using same-day prepared PBMCs isolated by a Ficoll gradient purification method. Other PBMC isolation methods, including cell sorting, have not been evaluated. In addition, freshly frozen PBMCs have been successfully tested using this protocol. For more information, see the *Single-Cell RNA Sequencing of Peripheral Blood Mononuclear Cells* Technical Note. PBMCs stored under other conditions may require further testing.
- ▶ **Fully dissociated single cells**—Single-cell encapsulation by the ddSEQ Single-Cell Isolator instrument requires single cell suspension as input. Cell aggregates or doublets present in the suspension will significantly increase the probability of doublets or multiplets during single-cell isolation on the ddSEQ, making data interpretation potentially more difficult. Depending on the method or cell counter device used, multiplets also can affect the accuracy of cell counting. While PBMCs rarely form doublets or clumps, perform a visual check under a microscope to confirm single cell status before proceeding to encapsulation.
- ▶ **Accurate cellcount**—Accurate cellcount is critical to achieve target cellthroughput and to avoid cell mutiplets. Illumina and Bio-Rad have validated an automated cell counter (Bio-Rad TC20) for cell counting of PBMC cells. Size-based gating for automated counters or manual count may be required to avoid counting cell debris. Both viable and non-viable cells should be included in total cell count. To ensure the accuracy of the PBMC cell count, the PBMC suspension should be free of red blood cells. The presence of red blood cells is indicated by a red or pink color of the pelleted PBMC.

- ▶ **High viability (>80%) and integrity**—Dead or damaged cells can release nucleic acids into the cell suspension buffer. This background signal from these cells remains through subsequent steps, and may impact the quality of the resulting analysis.

Library Prep Workflow

Figure 1 SureCell WTA 3' Library Prep Kit for the ddSEQ System Workflow



● Pre-PCR ● Post-PCR

Prepare, Count, and Assess Viability of Single-Cell Suspension

This section describes preparation of a single-cell suspension, counting of cells, and assessment of cell viability. The SureCell WTA 3' PBMC demonstrated protocol is optimized for a single-cell suspension input of 3000 cells/ μ l at greater than 80% viability with a minimum of 2500 c/ μ l. All four chambers of a cartridge must be loaded with cells. Up to two unique samples can be processed per cartridge. Each sample chamber requires 250,000 cells for processing. The expected output is ~500 cells per sample (or ~1000 cells per cartridge if loaded with the same sample).

After cells have been prepared, there are no safe stopping points until the Second Strand Synthesis has started. Proceed immediately to each step in the protocol.



CAUTION

Delays during cell preparation and handling can lead to sample failure. Make sure you have all required consumables (see *Consumables and Equipment* on page 43) before you begin. Do not stop during or between steps.

Consumables

- ▶ BSA (Bovine Serum Albumin)
- ▶ PBS (Phosphate-Buffered Saline)
- ▶ Trypan blue
- ▶ Hemacytometer or slides for cell counting
- ▶ Rainin pipettes
 - ▶ P200 single channel or P1000 single channel

Guidelines

- ▶ Review *Preliminary Cell Prep Optimization Guidelines* on page 5 before you begin.

Preparation

- ▶ Prepare 1X PBS + 0.1% and store on ice.

Procedure

- 1 Wash cells twice in cold 1X PBS + 0.1% BSA at a volume sufficient to remove carryover components from the media.
- 2 Centrifuge for 5-10 minutes at 250 x g and resuspend cells in the appropriate volume of cold 1X PBS + 0.1% BSA 3000 cells/ μ l. Keep cells on ice.
- 3 Use a microscope or automated cell counter imaging feature to assess cell viability and concentration.
- 4 Dilute the stock cell preparation to target 3000 cells/ μ l in 1X PBS + 0.1% BSA solution. Keep diluted cells on ice until use.



CAUTION

Cell concentration below 2500 cells/ μ l can adversely affect assay performance.

- 5 Proceed to *Prepare Cell and Barcode Suspension Mixes* on page 9 immediately after preparing the single-cell suspension.
Single-cell suspension can remain on ice for up to one hour before loading on the ddSEQ Single-Cell Isolator.

Figure 2 PBMC at 3000 cells/ μ l

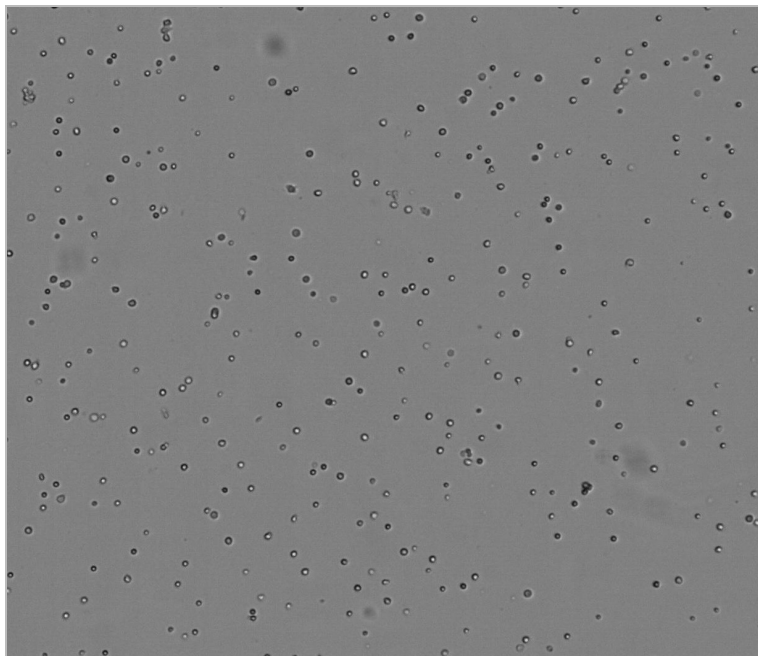

Prepare Cell and Barcode Suspension Mixes

This step prepares suspension mixes that add first strand synthesis components before loading on the ddSEQ Single-Cell Isolator.

Cell suspension mix includes all the reagents necessary to perform the first strand synthesis (RT) from the messenger RNA released from the single cell in the droplet after cell lysis.

Barcode suspension mix contains the barcoded beads and UMI (unique molecular identifier) elements that allow specific tagging of messenger RNA.

**CAUTION**

Delays during cell preparation and handling can lead to sample failure. Do not stop during or between steps.

Consumables

- ▶ Cell Suspend Buffer [red cap]
- ▶ DTT [red cap]
- ▶ RNA Stabilizer [red cap]
- ▶ RT Enzyme [red cap]
- ▶ Enhancer Enzyme [red cap]
- ▶ Barcode Buffer [blue cap]
- ▶ 3' Barcode Mix [blue cap]
- ▶ Rainin pipettes
 - ▶ P20 single channel and P200 single channel (use in *Procedure* on page 11)

Preparation

- 1 Prepare the following consumables:

Item	Storage	Instructions
Cell Suspend Buffer	-25°C to -15°C	Thaw on ice. Vortex vigorously to mix, and then centrifuge briefly.
DTT	-25°C to -15°C	Thaw at room temperature. Vortex to mix, then centrifuge briefly.
RNA Stabilizer	-25°C to -15°C	Gently invert the thawed tubes 3–5 times, and then centrifuge briefly.
RT Enzyme	-25°C to -15°C	Gently invert the thawed tubes 3–5 times, and then centrifuge briefly.
Enhancer Enzyme	-25°C to -15°C	Flick the thawed tubes 3–5 times, and then centrifuge briefly.
Barcode Buffer	-25°C to -15°C	Thaw on ice. Vortex vigorously to mix, and then centrifuge briefly.
3' Barcode Mix	2°C to 8°C	Gently invert the tube 3–5 times. Keep on ice. Vortex to mix before use.
Encapsulation Oil	2°C to 8°C	Let stand for 30 minutes to bring to room temperature. Invert the tube five times to mix. This will be used in <i>Isolate Single Cells</i> on page 12.
ddSEQ Priming Solution	2°C to 8°C	Let stand for 30 minutes to bring to room temperature. Vortex well to mix, then centrifuge briefly. This will be used in <i>Isolate Single Cells</i> on page 12.

Procedure

- 1 Create the cell enzyme mix by combining the following components (red caps) in a 1.7 ml tube on ice. Pipette the cell enzyme mix with a P200 single channel pipette 10–15 times while on ice, and then centrifuge briefly.



NOTE

It is normal to see bubbles after mixing and centrifugation.

Cell Enzyme Mix Component	Volume (µl) for 1 Cartridge (2 Samples)
Cell Suspend Buffer	60
DTT	8
RNA Stabilizer	6
RT Enzyme	13.2
Enhancer Enzyme	12
Total	99.2

- 2 Create the cell suspension mix for each cell type by combining the following components in a new 1.7 ml tube on ice. Before adding the filtered cells to the cell enzyme mix, vortex the cells for one second, and repeat three times.
 - a If loading two unique samples, make a single sample cell suspension mix for each cell type.
 - b To load the same cell sample across all four chambers, make a cell suspension mix using the volumes listed for one cartridge.
 - c All four sample chambers must be loaded with cell suspension mix. If you choose not to load any cells into a chamber, prepare and load the cell suspension mix, substituting an equivalent volume 1X PBS + 0.1% BSA in place of cells.

Cell Suspension Mix Component	Volume (µl) for 1 Sample (2 Chambers)	Volume (µl) for 1 Cartridge (2 Samples)
Celli Enzyme Mix	43	86
Cells (>2500 cells/µl)	9	18



NOTE

Proceed immediately to the next step. Do not mix the combined components until *Load Cartridge* on page 15.

- 3 Create the barcode suspension mix by combining the following components (blue caps) in a new 1.7 ml tube on ice. Before combining, resuspend the 3' Barcode Mix by vortexing for one second, repeat three times, and immediately add to the Barcode Buffer.

Barcode Suspension Mix Component	Volume (µl) for 1 Cartridge
Barcode Buffer	60
3' Barcode Mix	60



NOTE

Proceed immediately to the next step. Do not mix the combined components until *Load Cartridge* on page 15.

Isolate Single Cells

This step uses the ddSEQ Single-Cell Isolator to coencapsulate cells (samples) and barcodes in droplets that create a highly parallelized library prep for single-cell analysis.



CAUTION

Delays during cell preparation and handling can lead to sample failure. Do not stop during or between steps.

Consumables

- ▶ 96-well cooling block
- ▶ ddSEQ cartridge
- ▶ ddSEQ cartridge holder
- ▶ Rainin pipettes
 - ▶ P20 single channel and multichannel, P50 multichannel, P200 single channel and multichannel (use in *Prime Cartridge* on page 14, *Load Cartridge* on page 15, and *Transfer Samples* on page 18)
- ▶ Encapsulation Oil
- ▶ ddSEQ Priming Solution
- ▶ Bio-Rad ddPCR plate (Bio-Rad catalog # 12001925)
- ▶ 8-tube strip (General Lab Supplier)
- ▶ 8-tube strip caps (Bio-Rad, catalog # TCS-0803)
- ▶ Multichannel Pipette Reservoir

Guidelines

- ▶ Make sure the ddSEQ Single-Cell Isolator is installed according to manufacturer instructions and the power indicator is lit.
- ▶ Review pipetting guidelines in the ddSEQ Single-Cell Isolator Instruction Manual.
- ▶ Use Rainin pipettes and corresponding tips to load the cartridge. Use of other tips can negatively impact ddSEQ cartridge performance.
- ▶ Make sure that the ddSEQ cartridge is in the cartridge holder when loading reagents.
- ▶ Avoid static generation while handling encapsulated samples.
 - ▶ Work in a clear, static-free area.
 - ▶ Do not use latex gloves when making or handling droplets.

About Reagents

- ▶ To avoid bubbles, depress the pipette plunger only to the first stop when loading the cartridge.
- ▶ Aspirate and dispense Encapsulation Oil slowly due to the viscosity of the solution.

Preparation

Prepare Cartridge

- 1 Grip the cartridge by the tab and remove it from the package. Do not touch the wells or gaskets.

Figure 3 ddSEQ Cartridge

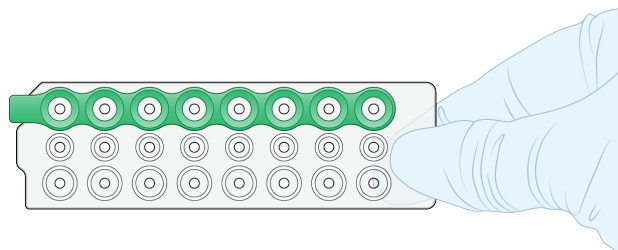

- 2 Insert the cartridge into the cartridge holder.
 - a Lift the cartridge holder lever.
 - b Orient the green gasket on the cartridge with the green stripe on the cartridge holder, insert the tab under the rails, then slide the cartridge into the holder.
 - c Check that the cartridge is fully inserted and lying flat against the bottom of the holder, then close the lever. If the lever does not close completely, reinsert the cartridge.

Figure 4 Insert Cartridge Into Cartridge Holder

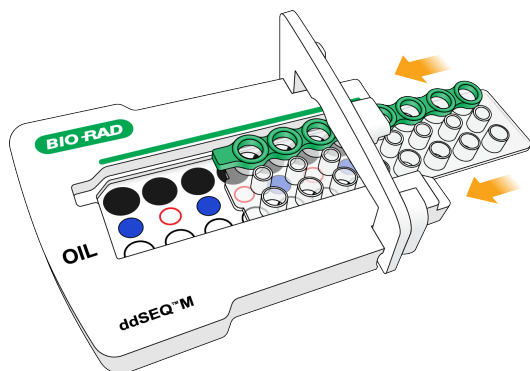
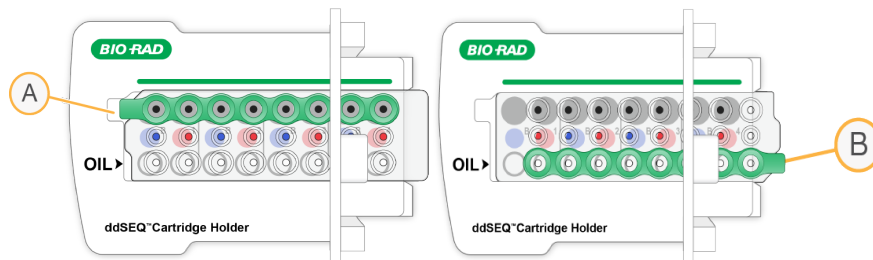
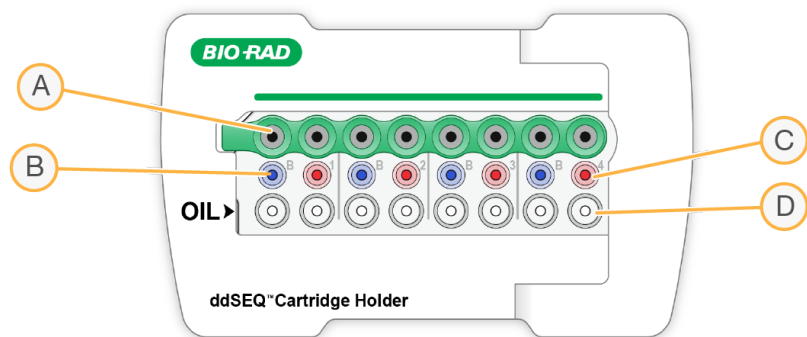

Figure 5 Incorrectly Assembled Cartridge and Cartridge Holder



- A Cartridge not fully inserted
- B Cartridge oriented incorrectly

Figure 6 Assembled Cartridge and Cartridge Holder



- A Encapsulated sample output wells
- B Barcode Suspension Mix input wells (Blue)
- C Cell Suspension Mix input wells (Red)
- D Encapsulation Oil input wells

Procedure

Prime Cartridge

Prime the ddSEQ cartridge to prepare fluidics for single cell isolation.

- 1 Use a P200 single channel pipette to add 25 μ l of ddSEQ Priming Solution to each well of an 8-tube strip.
- 2 Use a P20 multichannel pipette to add 20 μ l of ddSEQ Priming Solution from the 8-tube strip to each well of the second row of the cartridge as shown in Figure 7.



NOTE

Use a multichannel pipette to avoid missing wells during cartridge priming.

Figure 7 ddSEQ Priming Solution Wells

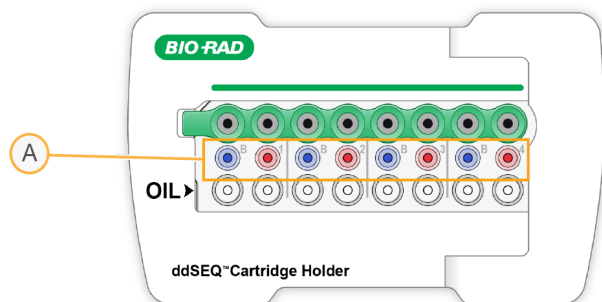

- A ddSEQ Priming Solution wells

- 3 Allow the ddSEQ Priming Solution to remain in wells for one minute, then remove with a P20 multichannel pipette set to 20 μ l.
Do not allow the ddSEQ Priming Solution to remain in wells longer than three minutes.



CAUTION

ddSEQ Priming Solution interferes with single cell isolation. Make sure all ddSEQ Priming Solution is removed from the wells.

Load Cartridge

Proper mixing of the barcode suspension mix and cell suspension mix provides even distribution into encapsulated droplets.

- 1 Vortex the barcode suspension mix for one second, and repeat three times.
- 2 Using a P20 single channel pipette, load 20 μ l of the barcode suspension mix into the bottom of the **B** ports (Blue). Depress the pipette plunger only to the first stop to avoid bubbles.

Figure 8 Barcode Suspension Mix Wells

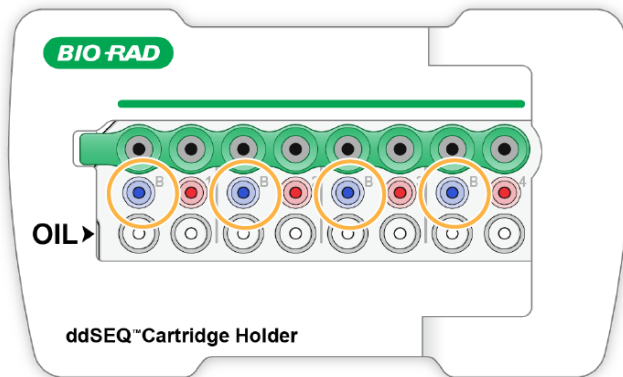

- 3 Vortex the cell suspension mix for one second, and repeat three times to create a homogeneous single cell suspension.
- 4 Using a P20 single channel pipette, load 20 μ l of cell suspension mix into the bottom of the red ports, numbered 1–4 if loading one sample. If loading two distinct samples, use ports 1–2 for sample 1 and ports 3–4 for sample 2. Do not use an intercalate sample loading scheme.
Depress the pipette plunger only to the first stop to avoid bubbles.

Figure 9 Cell Suspension Mix Wells for two distinct samples

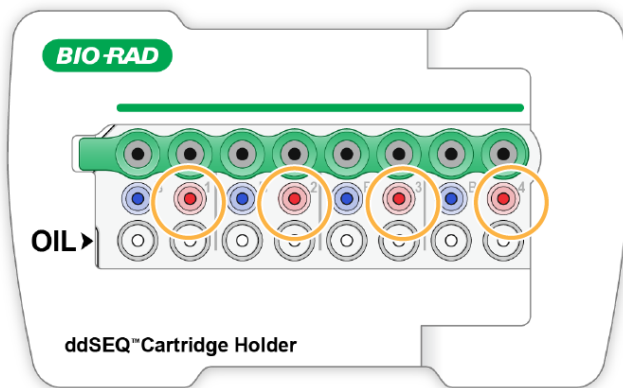

- 5 Pour the Encapsulation Oil into a multichannel pipette reservoir. Using a P200 multichannel pipette, load 80 µl of Encapsulation Oil into each well of the bottom row of the cartridge labeled OIL. Depress the pipette plunger only to the first stop to avoid bubbles.



NOTE

One bottle of Encapsulation Oil is enough for two cartridges.



CAUTION

Failure to load the Encapsulation Oil will result in single cell isolation failure and samples and reagents cannot be recovered.

- 6 Keep the loaded cartridge in the cartridge holder for single cell isolation on the ddSEQ Single-Cell Isolator.

Generate Single Cell Droplets

- 1 Press the silver button on the top of the ddSEQ Single-Cell Isolator to open the instrument.

Figure 10 Bio-Rad ddSEQ Single-Cell Isolator

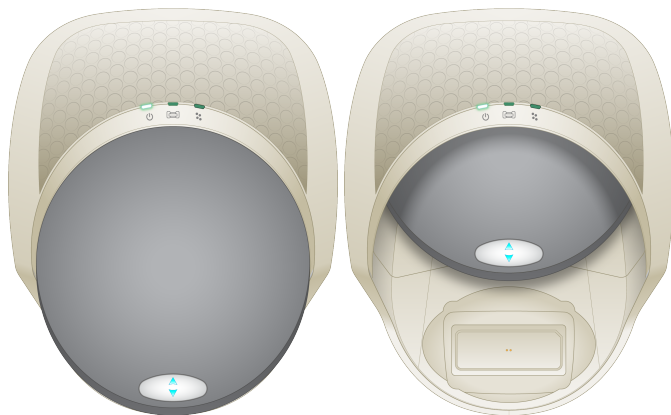

- 2 Place the cartridge holder into the instrument. Make sure that the cartridge indicator light is solid green to confirm that the cartridge holder is in the correct position. If the cartridge indicator light is not lit, reseal the cartridge holder on the magnetic plate.

Figure 11 ddSEQ Cartridge Loaded on ddSEQ Single-Cell Isolator



- 3 Press the silver button on the top of the ddSEQ Single-Cell Isolator to close the instrument . Single-cell isolation begins automatically after the ddSEQ Single-Cell Isolator door is closed and takes approximately five minutes. The droplet indicator flashes green to indicate that cell isolation is in progress. Single-cell isolation is complete when all three indicator lights are solid green.



CAUTION

Do not proceed until all three indicator lights are solid green.

- 4 Press the silver button on the front of the ddSEQ Single-Cell Isolator to open the instrument.



NOTE

After the door opens, the instrument continues to make noise for ~five seconds while it resets.

- 5 Remove the cartridge holder from the ddSEQ Single-Cell Isolator. Successfully encapsulated samples appear cloudy in the output wells. Check for wells that look clear or empty, as droplet generation may have failed. Note clear or empty wells in the *Lab Tracking Chart* on page 39.

Figure 12 Encapsulated Samples in Output Wells

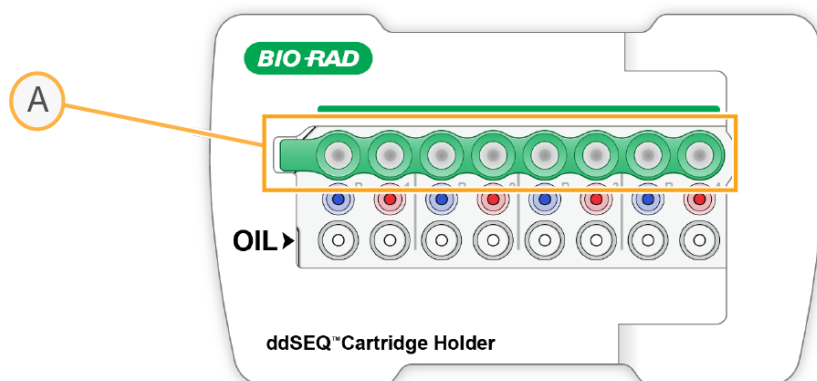

A Output wells



NOTE

Proceed *immediately* to the next step.

Transfer Samples

Encapsulated samples are transferred to a 96-well cooling block and kept cold until starting reverse transcription. Keeping the encapsulated samples cold at this step ensures stability of barcoded RNA and encapsulated droplets.

- 1 Chill a 96-well plate by securely placing it on a chilled 96-well cooling block.



NOTE

Avoid static generation while handling encapsulated samples.

- 2 Use a P50 multichannel pipette set at 43 μ l to gently and slowly aspirate all encapsulated sample from the output wells. Fast or harsh pipetting will break the encapsulated samples. Pipette very slowly to avoid yield loss.



CAUTION

Using a single channel pipette to individually transfer encapsulated samples will result in uneven sample volumes.

Figure 13 Emulsion Layers

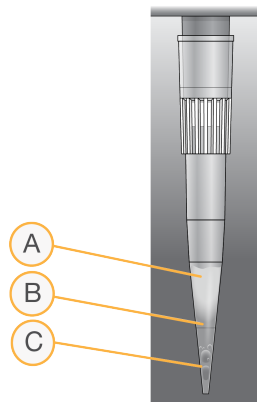

- A Aqueous layer
- B Oil layer
- C Oil + air bubbles



NOTE

The total emulsion volume transferred to each well is 35–40 μ l and ~5 μ l of air.

- 3 Dispense the encapsulated sample as follows.
 - a Very slowly dispense the encapsulated sample into the corresponding column of the plate, as shown in Figure 14. Dispense should take approximately five seconds.



CAUTION

Do not discard tips until all of the encapsulated sample has been transferred to the plate. Discarding tips with sample will result in yield loss.

- b Wait five seconds for remaining encapsulated sample to collect at the tip of the pipette.
- c Slowly dispense the remaining encapsulated sample into the same column of the plate.

Figure 14 Transferring Encapsulated Samples (two unique samples)



- Cover sample wells using an 8-tube strip cap and keep samples on the 96-well cooling block until *Reverse Transcribe Samples* on page 19.



CAUTION

Plastic plate seals can generate static and impact encapsulated samples. Use 8-tube strip caps to seal wells. Other plate seals may generate static and adversely affect encapsulated samples.

- If you are processing a second cartridge, proceed to *Prepare Cartridge* on page 13. Add encapsulated samples from each additional cartridge to a new column of the same 96-well plate.



NOTE

If you are processing more than four cartridges, contact [Illumina Technical Support](#) for a modified protocol.

- If you have finished processing cartridges, proceed to *Reverse Transcribe Samples* on page 19. Liquid remaining in the input wells after droplet generation is due to flushing sample from the input wells—this is not left over sample. When removing the cartridge from the cartridge holder, do not invert the cartridge. Dispose of cartridges according to standard laboratory procedures.

Reverse Transcribe Samples

This step reverse transcribes samples on a thermal cycler.

Guidelines

- ▶ Keep the plate on the 96-well cooling block while transporting to the thermal cycler.
- ▶ Work in a clear, static-free area, and avoid static generation while handling encapsulated samples.

Preparation

- Save the following Reverse Transcription (RT) program on a thermal cycler:
 - ▶ Choose the preheat lid option and set to 105°C
 - ▶ Set the reaction volume to 50 µl
 - ▶ 37°C for 30 minutes
 - ▶ 50°C for 60 minutes
 - ▶ 85°C for five minutes
 - ▶ Hold at 4°C

Procedure

- 1 Place the 96-well plate on the thermal cycler and run the RT program.



CAUTION

Do not vortex or spin down the plate before placing on the thermal cycler.

- 2 Remove Purification Beads (SPB) from storage and bring to room temperature for the *Clean Up First Strand Synthesis* on page 21.

Break Emulsion

This step breaks the individual droplets containing barcoded sample cells for further sample processing.

Consumables

- ▶ Droplet Disruptor
- ▶ Nuclease-free water
- ▶ Rainin pipettes
 - ▶ P20 single channel and P200 single channel

Preparation

- 1 Prepare the following consumables:

Item	Storage	Instructions
Droplet Disruptor	2°C to 8°C	Vortex 3–5 times immediately before use to mix, then centrifuge briefly. This reagent can be kept at room temperature during use.

Procedure

- 1 Remove the 96-well plate from the thermal cycler.



CAUTION

Do not vortex or spin down the plate after removing it from the thermal cycler.

- 2 Visually examine the samples which should all have equal volumes. Each sample has two distinct layers, an oil layer on the bottom and an aqueous layer on top. Note if any wells have only one layer in the *Lab Tracking Chart* on page 39.
- 3 Remove the 8-tube strip caps carefully to avoid cross-sample contamination.
- 4 Add 20 µl of Droplet Disruptor by dispensing slowly against the side of the well above each sample. Do not mix or pipette Droplet Disruptor into the sample.
- 5 Wait 30 seconds, then add 100 µl of water by dispensing against the side of the well above each sample. Do not mix or pipette water into the sample.

Figure 15 Sample Emulsion Layers

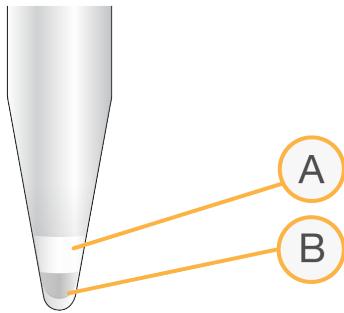

- A Emulsion layer
- B Oil layer



NOTE

Proceed *immediately* to the next step.

Clean Up First Strand Synthesis

This step uses Purification Beads (SPB) to purify the first strand product (library cDNA), provides a selection step that removes short fragments (unbound barcodes), and combines the two output volumes from each sample into a single well.

Consumables

- ▶ Resuspension Buffer (RSB)
- ▶ Purification Beads (SPB)
- ▶ Freshly prepared 80% ethanol (EtOH)
- ▶ Pipettes
 - ▶ P20 single channel and P200 single channel and multichannel
- ▶ 96-well plate seal

Equipment

- ▶ Magnetic peg stand (Thermo Fisher, catalog #AM10027)
- ▶ DynaMag 96 Side Magnet (Thermo Fisher, catalog # 12331D) or the DynaMag 96 Side Skirted Magnet (Thermo Fisher catalog # 12027)

About Reagents

- ▶ See *Handling Purification (Magnetic) Beads* on page 4 for details about working with Purification Beads (SPB).

About Samples

- ▶ Sample wells contain separate oil and aqueous layers during this step. When mixing, mix only in the specified layer.

About Magnets

- ▶ This procedure uses two types of magnetic stands. Both are needed in this protocol and are not interchangeable.

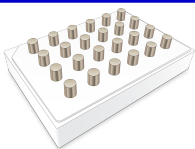
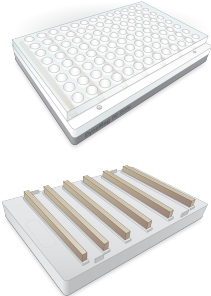
Magnet Type	Illustration	Step Procedure
Magnetic Peg Stand		Use this magnet with <i>Bind</i> on page 22 and <i>Wash</i> on page 24.
DynaMag 96 Side Magnet or DynaMag 96 Side Skirted Magnet		Use either DynaMag magnet with <i>Elute</i> on page 24.

Guidelines

- ▶ Use a single channel pipette to transfer Purification Beads (SPB) to sample wells. Using a multichannel pipette reservoir and a multichannel pipette results in inadequate Purification Beads (SPB) reagent volume needed to complete this protocol.
- ▶ This process requires both a magnetic peg stand and either DynaMag side magnet.

Preparation

- 1 Prepare the following consumables:

Item	Storage	Instructions
Resuspension Buffer (RSB)	2°C to 8°C	Can be used after removing from 2°C to 8°C. Do not discard until the protocol is complete.
Purification Beads (SPB)	2°C to 8°C	Let stand for 15 minutes to bring to room temperature.

- 2 Prepare fresh 80% ethanol from absolute ethanol.

Procedure

Bind

- 1 Vortex Purification Beads (SPB) until well-dispersed.
- 2 Use a P200 single channel pipette to add 90 µl Purification Beads (SPB) to the samples by dispensing slowly above the aqueous layer without mixing. Do not dispense into the oil layer at the bottom of the well.
- 3 Use a P200 single channel pipette, set to 50 µl, to pipette mix Purification Beads (SPB) *in the aqueous layer only* until the layer is evenly distributed (10-15 times).
After mixing, the samples have two distinct layers: an oil layer on the bottom of the well and a homogeneous brown aqueous layer on the top.

- Lift the plate to examine the quality of mix for the aqueous layer closely.



CAUTION

The aqueous layer should not appear clear at the top. If parts of the aqueous layer still appear clear or a lighter brown, continue to mix until the entire aqueous layer is homogenously brown.

Figure 16 Mixing States From Initial State to Properly Mixed State

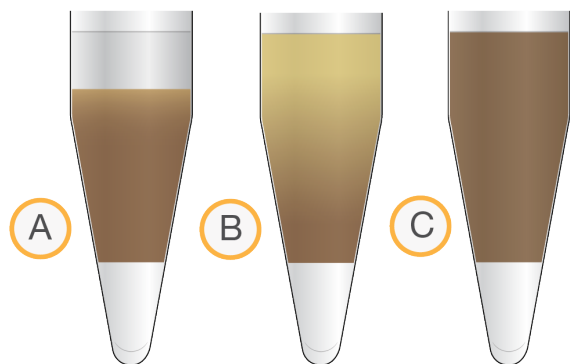

- A Initial state with a clear aqueous layer at the top
- B Not properly mixed, indicated by a lighter brown aqueous layer at the top
- C Properly mixed with an entirely homogenous brown aqueous layer

Figure 17 Mixed Aqueous Layer and Oil Layer

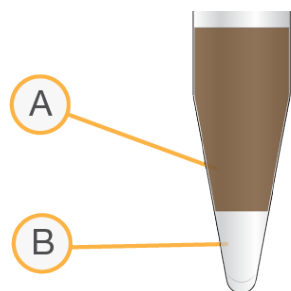

- A Mixed aqueous layer
- B Oil layer

- Incubate at room temperature for 10 minutes.
- Place on a magnetic peg stand and wait 10 minutes. Use a magnetic peg stand until *Elute* on page 24.



NOTE

The liquid might not be completely clear of beads due to retention of beads in the aqueous and oil layers.

- Use a P200 single channel pipette, set to 200 μ l, to remove and discard all supernatant from each well. Use a fresh pipette tip to go into the well again to discard approximately 20-30 μ l more of supernatant.

Wash

- 1 Wash two times as follows.
 - a Add 200 μ l freshly prepared 80% EtOH to each well.
 - b Incubate on the magnetic peg stand for 30 seconds.
 - c Remove and discard all supernatant from each well.
 - d Repeat steps a - c to wash again.
- 2 Seal the plate and centrifuge at 280 \times g for 10 seconds to bring down any ethanol or liquid remaining on sides of wells.
- 3 Place on a magnetic peg stand and wait 30 seconds.
- 4 Use a P20 single channel pipette to remove residual 80% EtOH from each well.
- 5 Air-dry on the magnetic peg stand for five minutes.

Elute

- 1 Remove the sample plate from the magnetic peg stand.
- 2 Use a P20 single channel pipette to add 18 μ l Resuspension Buffer (RSB) to each sample well. Pipette to mix, making sure all beads are resuspended.



CAUTION

Yield loss can occur if beads are not thoroughly resuspended.

- 3 Incubate at room temperature for two minutes.
- 4 Seal the plate and centrifuge at 280 \times g for 10 seconds.
- 5 Place on a DynaMag 96 side magnet and wait two minutes.



NOTE

You may proceed to the next step even if the solution is not completely clear after two minutes.

Combine Wells from Sample and Transfer

- 1 Using a P20 single channel pipette, combine the four wells for each sample into a single well by transferring 17 μ l of supernatant from each sample well to a new plate, as follows. Keep the sample plate on the DynaMag 96 side magnet during this step.
 - ▶ Sample 1, rows A—D to row A of the corresponding column in the new plate.
 - ▶ Sample 2, rows E—H to row B of the corresponding column in the new plate.After transferring, the total volume of supernatant in each well of the new plate is 68 μ l.



CAUTION

Each four sample wells in succession represent **one** sample. Proper pooling is critical for library prep indexing and sample processing.

Figure 18 Combining Barcoded Samples (two unique samples)

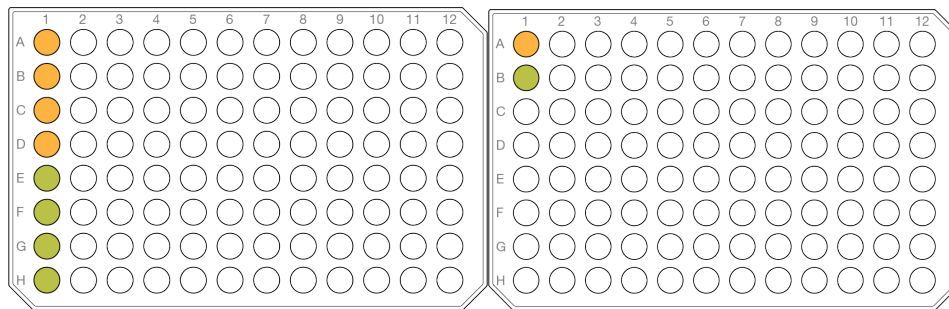
**NOTE**

Proceed *immediately* to the next step.

Synthesize Second Strand cDNA

This process removes the RNA template and synthesizes a replacement strand to generate double stranded cDNA.

Consumables

- ▶ Second Strand Buffer (SSB)
- ▶ Second Strand Enzyme (SSE)
- ▶ Pipettes
 - ▶ P20 single channel and P200 multichannel

About Reagents

- ▶ Second Strand Enzyme (SSE) is viscous and pipettes slowly. Ensure that the specified volume is obtained.

Preparation

- 1 Prepare the following consumables:

Item	Storage	Instructions
Second Strand Buffer (SSB)	-25°C to -15°C	Thaw on ice. Vortex to mix, and then centrifuge briefly. Keep on ice until use.
Second Strand Enzyme (SSE)	-25°C to -15°C	Thaw on ice. Pipette mix and then centrifuge briefly. Keep on ice until use.

- 2 Save the following Second Strand Synthesis (SSS) program on the thermal cycler:
 - ▶ Turn off the heated lid function
 - ▶ Set the reaction volume to 80 μ l
 - ▶ 16°C for two hours
 - ▶ Hold at 4°C

Procedure

- 1 Prepare Second Strand Synthesis Master Mix by adding the following to a 1.7 ml tube on ice. Pipette 10 times to mix.

Second Strand Synthesis Component	Volume (µl) for 1 Cartridge (2 Samples)
Second Strand Buffer (SSB)	18
Second Strand Enzyme (SSE)	9

- 2 Using a P20 single channel pipette, add 12 µl of Second Strand Master Mix to each sample well.
- 3 Using a P200 multichannel pipette set to 40 µl, pipette to thoroughly mix each sample well.
- 4 Seal the plate and centrifuge at 280 × g for 10 seconds.
- 5 Place on the preprogrammed thermal cycler and run the Second Strand Synthesis (SSS) program.

SAFE STOPPING POINT

If you are stopping, leave the plate on the thermal cycler at 4°C overnight or store at -25°C to -15°C for up to two days.

Clean Up cDNA

This process uses Purification Beads (SPB) to purify the library DNA and provides a selection step that removes short library fragments.

Consumables

- ▶ Resuspension Buffer (RSB)
- ▶ Purification Beads (SPB)
- ▶ Freshly prepared 80% ethanol (EtOH)
- ▶ Pipettes
 - ▶ P20 single channel and P200 single channel and multichannel
- ▶ 96-well plate seal

Equipment

- ▶ Magnetic peg stand (Thermo Fisher, catalog # AM10027)
- ▶ DynaMag 96 Side Magnet (Thermo Fisher, catalog # 12331D) or the DynaMag 96 Side Skirted Magnet (Thermo Fisher catalog # 12027)

About Reagents

- ▶ See *Handling Purification (Magnetic) Beads* on page 4 for details about working with Purification Beads (SPB).

About Magnets

- ▶ This procedure uses two types of magnetic stands. Both are needed in this protocol and are not interchangeable.

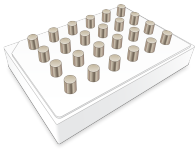
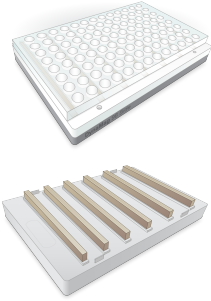
Magnet Type	Illustration	Step Procedure
Magnetic Peg Stand		Use this magnet with <i>Bind</i> on page 27 and <i>Wash</i> on page 28.
DynaMag 96 Side Magnet or DynaMag 96 Side Skirted Magnet		Use either DynaMag magnet with <i>Elute</i> on page 28.

Guidelines

- ▶ Use a single channel pipette to transfer Purification Beads (SPB) to sample wells. Using a multichannel pipette reservoir and a multichannel pipette results in inadequate Purification Beads (SPB) reagent volume needed to complete this protocol.
- ▶ This process requires both a magnetic peg stand and either DynaMag side magnet.

Preparation

- 1 Prepare the following consumables:

Item	Storage	Instructions
Resuspension Buffer (RSB)	2°C to 8°C	Do not discard until the protocol is complete.
Purification Beads (SPB)	2°C to 8°C	Let stand for 30 minutes to bring to room temperature.

- 2 Prepare fresh 80% ethanol from absolute ethanol.

Procedure

Bind

- 1 Centrifuge sample plate at 280 × g for 30 seconds.
- 2 Vortex Purification Beads (SPB) until well-dispersed.
- 3 Use a P200 single channel pipette to add 44 µl Purification Beads (SPB) to each sample well. Pipette mix until evenly distributed (10–15 times).
- 4 Incubate at room temperature for five minutes.
- 5 Place on a magnetic peg stand until the liquid is clear (~five minutes). Use a magnetic peg stand until *Elute* on page 28.
- 6 Use a P200 pipette, set to 120 µl, to remove and discard all supernatant from each well.

Wash

- 1 Wash two times, as follows.
 - a Add 200 μ l freshly prepared 80% EtOH to each well.
 - b Incubate on the magnetic stand for 30 seconds.
 - c Remove and discard all supernatant from each well.
- 2 Air-dry on the magnetic peg stand for five minutes.
- 3 Using a P20 pipette, remove residual 80% EtOH from each well.

Elute

- 1 Remove from the magnetic peg stand.
- 2 Using a P20 single channel pipette, add 11 μ l Resuspension Buffer (RSB) to each sample well. Pipette to mix, making sure all beads are resuspended.



CAUTION

Yield loss can occur if beads are not thoroughly resuspended.

- 3 Incubate at room temperature for two minutes.
- 4 Seal the plate and centrifuge at $280 \times g$ for 10 seconds to bring entire solution to the bottom of the well.
- 5 Place on a DynaMag 96 side magnet and wait until the liquid is clear (~two minutes).
- 6 Transfer 10 μ l of supernatant from each sample well to a new sample well of a 96-well plate.

Check Libraries

Perform the following optional procedure for quality control analysis on your sample library.

- 1 Run 1 μ l of undiluted library on an Agilent Technology 2100 Bioanalyzer using a High Sensitivity DNA chip.
- 2 Drag the blue regions to capture the 200-8000 bp range.
- 3 Record the cDNA library fragment size and cDNA yield. See *Lab Tracking Chart* on page 39.
An example of the resulting cDNA prepared using this protocol is shown in [Figure 19](#). cDNA yields are calculated as follows: $X \text{ ng}/\mu\text{l} * 10 \text{ ul of cDNA} = \text{ng cDNA yield}$. cDNA yields for PBMC samples can be as low as 0.5 ng, with an average of 1.85 ng.

Figure 19 Example of Bioanalyzer cDNA Product for PBMC

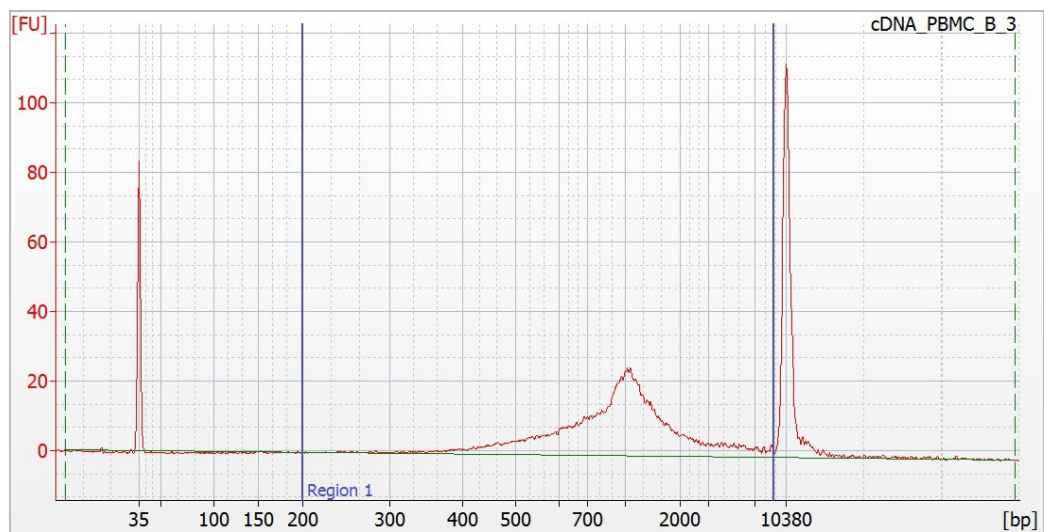

Tagment cDNA

This step uses the Nextera SureCell transposome to tagment cDNA, which is a process that simultaneously fragments and tags DNA with adapter sequences in a single step.

Consumables

- ▶ Tagment Buffer (TCB)
- ▶ Tagment Enzyme (TCE)
- ▶ Tagment Stop Buffer (TSB)
- ▶ 96-well plate seal
- ▶ Pipettes
 - ▶ P20 single channel and P200 single channel

Preparation

- 1 Prepare the following consumables.

Item	Storage	Volume (µl)
Tagment Buffer (TCB)	-25°C to -15°C	Thaw on ice. Vortex to mix, and then centrifuge briefly.
Tagment Enzyme (TCE)	-25°C to -15°C	Thaw on ice. Gently invert the thawed tubes 3–5 times, and then centrifuge briefly.
Tagment Stop Buffer (TSB)	15°C to 30°C	Check for precipitates. If present, vortex until all particulates are resuspended.

- 2 Save the following Tagmentation Program (TGM) on the thermal cycler.
 - ▶ Choose the preheat lid option (105 degrees)
 - ▶ Set the reaction volume to 40 µl
 - ▶ 55°C for five minutes
 - ▶ Hold at 4°C

Procedure

- 1 Prepare Tagmentation Mix in a 1.7 ml tube on ice as follows. Pipette 10 times to mix.

Tagmentation Mix Component	Volume (µl) for 1 Cartridge (2 Samples)
Tagment Buffer (TCB)	44
Tagment Enzyme (TCE)	22

- 2 Add 30 µl of Tagmentation Mix to each sample well. Mix with pipette.
- 3 Seal the plate and centrifuge at 280 × g for 10 seconds.
- 4 Place on the preprogrammed thermal cycler and run the TGM program.
- 5 Remove the plate from the thermal cycler as soon as the temperature reaches 4° C. Do not leave the PCR plate on the thermal cycler for longer than six minutes.
- 6 Remove the seal carefully to avoid cross-sample contamination.
- 7 Use a P20 pipette to add 10 µl of Tagment Stop Buffer to each well. Pipette to mix with a P200 pipette.
- 8 Seal the plate and centrifuge at 280 × g for 10 seconds.
- 9 Incubate at room temperature for five minutes.

Amplify Tagmented cDNA

This step uses a 15-cycle PCR program to amplify tagmented cDNA and add DNA adapters required for cluster generation. To ensure that your libraries produce high-quality sequencing results, use the specified number of PCR cycles.

Consumables

- ▶ Tagmentation PCR Mix (TPM)
- ▶ Tagment PCR Adapter (TPP1)
- ▶ DNA Adapters (N7XX)
- ▶ 96-well plate seal
- ▶ Pipettes
 - ▶ P20 single channel and P200 single channel and multichannel

Preparation

- 1 Prepare the following consumables.

Item	Storage	Instructions
DNA Adapters	-25°C to -15°C	Only remove adapters being used. Thaw at room temperature for 20 minutes. Vortex to mix, and then centrifuge briefly.
Tagmentation PCR Mix (TPM)	-25°C to -15°C	Thaw on ice. Gently invert the thawed tubes 3–5 times, and then centrifuge briefly.
Tagment PCR Adapter (TPP1)	-25°C to -15°C	Thaw at room temperature for 20 minutes. Vortex to mix, and then centrifuge briefly.

- 2 Save the following Library Amplification (LA) program on the thermal cycler:
 - ▶ Choose the preheat lid option and preheat to 105°C

- ▶ Set the reaction volume to 100 µl
- ▶ 95°C for 30 seconds
- ▶ 15 cycles of:
 - ▶ 95°C for 10 seconds
 - ▶ 60°C for 45 seconds
 - ▶ 72°C for 60 seconds
- ▶ 72°C for five minutes
- ▶ Hold at 4°C

Procedure

- 1 Arrange the DNA Adapters in a tube rack. Use a different index for each sample well. Record the DNA Adapter index used for each sample well.
This information will be required when setting up the sequencing run.
- 2 Using a P200 single channel pipette, add 30 µl of Tagmentation PCR Mix (TPM) to each of the tagmented samples.
- 3 Using a P20 single channel pipette, add 10 µl of Tagment PCR Adapter (TPP1) to each of the tagmented samples.
- 4 Using a P20 single channel pipette, add 10 µl of each DNA Adapter to each tagmented sample.
DNA Adapters are one time use and do not require new orange caps.
- 5 Use a P200 multichannel Pipette to mix 10-15 times.
- 6 Seal the plate and centrifuge at 280 × g at 20°C for 30 seconds.
- 7 Place on the preprogrammed thermal cycler and run the LA program.

SAFE STOPPING POINT

If you are stopping, leave the plate on the thermal cycler at 4°C overnight or store at -25°C to -15°C for up to two days.

Clean Up Libraries

This process uses Purification Beads (SPB) to purify the library DNA and provides a selection step that removes short library fragments.

Consumables

- ▶ Resuspension Buffer (RSB)
- ▶ Purification Beads (SPB)
- ▶ Freshly prepared 80% ethanol (EtOH)
- ▶ Pipettes
 - ▶ P20 single channel and P200 single channel and multichannel
- ▶ 96-well plate seal

Equipment

- ▶ Magnetic peg stand (Thermo Fisher, catalog #AM10027)
- ▶ DynaMag 96 Side Magnet (Thermo Fisher, catalog # 12331D) or the DynaMag 96 Side Skirted Magnet (Thermo Fisher catalog # 12027)

About Reagents

Document # 1000000044179 v00

For Research Use Only. Not for use in diagnostic procedures.

- ▶ See *Handling Purification (Magnetic) Beads* on page 4 for details about working with Purification Beads (SPB).

About Magnets

- ▶ This procedure uses two types of magnetic stands. Both are needed in this protocol and are not interchangeable.

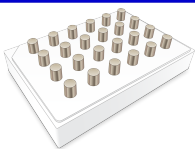
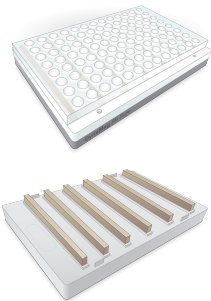
Magnet Type	Illustration	Step Procedure
Magnetic Peg Stand		Use this magnet with <i>Bind</i> on page 32 and <i>Wash</i> on page 33.
DynaMag 96 Side Magnet or DynaMag 96 Side Skirted Magnet		Use either DynaMag magnet with <i>Elute</i> on page 33.

Guidelines

- ▶ Use a single channel pipette to transfer Purification Beads (SPB) to sample wells. Using a multichannel pipette reservoir and a multichannel pipette results in inadequate Purification Beads (SPB) reagent volume needed to complete this protocol.
- ▶ This process requires both a magnetic peg stand and either DynaMag side magnet.

Preparation

- 1 Prepare the following consumables.

Item	Storage	Instructions
Resuspension Buffer (RSB)	2°C to 8°C	Do not discard until the protocol is complete.
Purification Beads (SPB)	2°C to 8°C	Let stand for 30 minutes to bring to room temperature.

- 2 Prepare fresh 80% ethanol from absolute ethanol.

Procedure

Bind

- 1 Centrifuge sample plate at $280 \times g$ for 30 seconds.
- 2 Vortex Purification Beads (SPB) until well-dispersed.
- 3 Using a P200 single channel pipette, add 58 μ l of Purification Beads (SPB) to each sample well. Pipette to mix, making sure that all beads are resuspended.
- 4 Incubate at room temperature for five minutes.

- 5 Place on a 96-well magnetic peg stand until the liquid is clear (~five minutes). Use a magnetic peg stand until *Elute on page 33*.
- 6 Remove and discard all supernatant from each well.

Wash

- 1 Wash two times, as follows.
 - a Add 200 μ l freshly prepared 80% EtOH to each well.
 - b Incubate on the magnetic stand for 30 seconds.
 - c Remove and discard all supernatant from each well.
- 2 Using a P20 pipette, remove residual 80% EtOH from each well.
- 3 Air-dry on the magnetic peg stand for five minutes.

Elute

- 1 Remove from the magnetic peg stand.
- 2 Using a P200 pipette, add 51 μ l of Resuspension Buffer (RSB) to each sample well. Pipette mix until beads are thoroughly resuspended.
- 3 Incubate at room temperature for two minutes.
- 4 Apply the seal and centrifuge at $280 \times g$ for 10 seconds to bring entire solution to the bottom of the well.
- 5 Place on a DynaMag 96 side magnet until the liquid is clear (~two minutes). Use a DynaMag 96 side magnet until *Second Bind on page 33*.
- 6 Transfer 50 μ l of supernatant from each sample well to a new sample 96-well plate.

Second Bind

- 1 Vortex Purification Beads (SPB) until well-dispersed.
- 2 Add 30 μ l of Purification Beads (SPB) to each sample well. Use a P200 to pipette until evenly distributed (10-15 times).
- 3 Incubate at room temperature for five minutes.
- 4 Place on a magnetic peg stand until the liquid is clear (~five minutes). Use a magnetic peg stand until *Second Elute on page 34*.
- 5 Remove and discard all supernatant from each well.

Second Wash

- 1 Wash two times, as follows.
 - a Add 200 μ l freshly prepared 80% EtOH to each well.
 - b Incubate on the magnetic stand for 30 seconds.
 - c Remove and discard all supernatant from each well.
- 2 Using a P20 pipette, remove residual 80% EtOH from each well.
- 3 Air-dry on the magnetic peg stand for five minutes.

Second Elute

- 1 Remove the 96-well plate from the magnetic peg stand.
- 2 Add 11 μ l Resuspension Buffer (RSB) to each sample well. Using a P200, pipette mix until beads are resuspended.
- 3 Incubate at room temperature for two minutes.
- 4 Seal the plate and centrifuge at $280 \times g$ for 10 seconds to bring entire solution to the bottom of the well.
- 5 Place on a DynaMag 96 side magnet until the liquid is clear (~two minutes).
- 6 Transfer 10 μ l of supernatant from each sample well to a new 96-well plate.

SAFE STOPPING POINT

If you are stopping, seal the plate and store at -25°C to -15°C for up to seven days.

Assess Libraries

Accurately quantify DNA libraries to ensure optimum cluster densities on the flow cell.

- 1 Run 1 μ l undiluted library on an Agilent Technology 2100 Bioanalyzer using a High Sensitivity DNA chip.
- 2 Determine the concentration of the library using the Agilent Technology 2100 Bioanalyzer.
- 3 Select the **Region Analysis** tab.
- 4 Drag the blue region lines to capture the 200–8000 bp region. Record the final library fragment size and final library yield. See *Lab Tracking Chart* on page 39.
The following figure shows an example trace of a successfully sequenced library. Typical libraries show a broad size distribution ~300–1000 bp. A wide variety of libraries can be sequenced with average fragment sizes as small as 450 bp or as large as 1200 bp.

Figure 20 Example of Library Size Distributions for PBMC: blue trace = 0.4 nM library yield. Red trace - 1.6 nM library yield

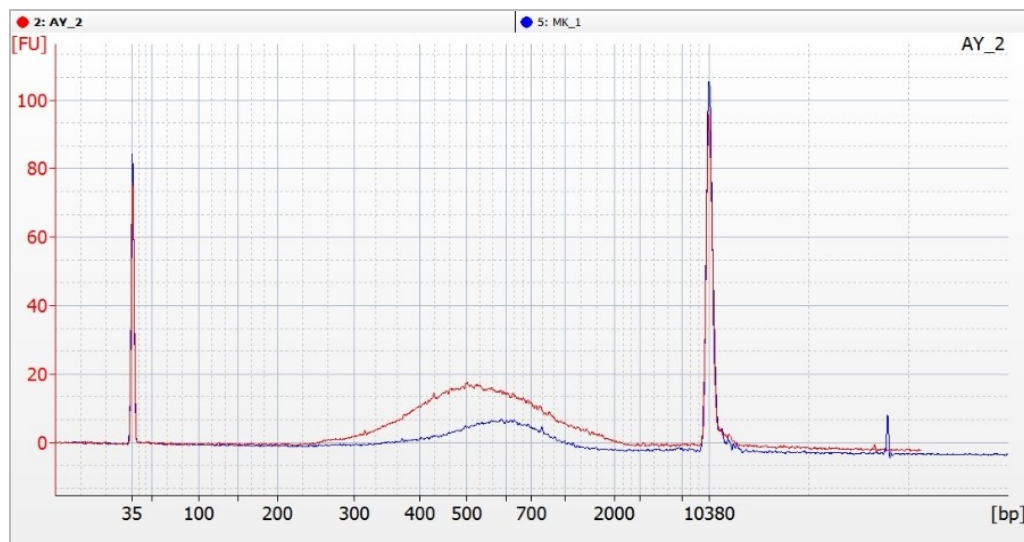

- 5 Typical library yield is 1.5-2.5 nM, but yields as low as 0.5 nM have been observed and successfully sequenced on NextSeq. For more information, see the *NextSeq System Denature and Dilute Libraries Guide (15048776)*. For library yields > 2nM, normalize samples to 2 nM.

Prepare for Sequencing

The PBMC protocol is intended for use only on the NextSeq platform. Use the SureCell Sequencing Primer for your sequencing runs. The Sequencing Primer (SP) is concentrated at 50 μ M and must be diluted according to the custom sequencing primer documentation for the NextSeq platform. See *Additional Resources* on page 1.

Confirm that [Illumina Experiment Manager v1.13](#) or later is used to set up the sequencing sample sheet if the BaseSpace Prep Tab is not used. Version 1.13 or later has the appropriate UMI settings and index sequences for sample demultiplexing. If demultiplexing outside of BaseSpace Sequence Hub, confirm that [bcl2fastq v2.18](#) or later is used for FASTQ Generation.



NOTE

SureCell Sequencing Primer is compatible with this library and PhiX only.

Consumables

- ▶ Sequencing Primer (SP) (50 μ M)
- ▶ [Optional] PhiX Control v3

Custom Primer Guide

- ▶ NextSeq System Custom Primers Guide (document # 15057456)

NextSeq Loading Concentration

The SureCell loading concentration for the NextSeq platform is 3pM, based on BioAnalyzer quantification. If you are quantifying with another method, you may need to optimize the loading concentration.

Sequence in Your Lab

- 1 Follow the instructions for using custom primers for a sequencing run on the NextSeq platform. See *Additional Resources* on page 1.



CAUTION

For NextSeq runs connected to BaseSpace Sequence Hub, select the SureCell WTA 3' Library Prep kit during Prep Tab setup to ensure that the Custom Primer R1 option is automatically selected on the Planned Runs screen. This option **must be selected** or the sequencing run fails.



NOTE

[Optional] Add a 1% PhiX control spike-in as a positive control for alignment and error rate calculations. For more information, see the PhiX Control v3 support page on the Illumina website.

Sequence Using an Outside Lab

- 1 Consult with your sequencing lab about dilution of Sequencing Primer (SP) and dilute accordingly.
- 2 Send Sequencing Primer (SP) with the quantified libraries.
The lab adds the Sequencing Primer (SP) to the appropriate sequencing reagents for the Illumina instrument used for sequencing.

- 3 [Optional] Add a 1% PhiX control spike-in as a positive control for alignment and error rate calculations. For more information, see the PhiX Control v3 support page on the Illumina website.

Supporting Information

Introduction	37
How does the SureCell WTA 3' Assay Work?	37
Cell Counting Protocol	37
Lab Tracking Chart	39
Acronyms	40
Kit Options	40
Consumables and Equipment	43

Introduction

The protocol described in this guide assumes that you have reviewed the contents of this section, confirmed workflow contents, and obtained all required consumables and equipment.

How does the SureCell WTA 3' Assay Work?

Single cells are individually partitioned into subnanoliter droplets on a disposable cartridge using the Bio-Rad ddSEQ™ Single-Cell Isolator. Cell lysis and cell barcoding of mRNA transcripts takes place in each droplet during reverse transcription. Then droplets are disrupted, and the barcoded cDNA is pooled for second strand synthesis in bulk. Double-stranded cDNA is tagged by Nextera SureCell transposome to add primer binding sites for subsequent indexing and amplification by PCR. Final libraries are purified and ready for sequencing on Illumina sequencing platforms.

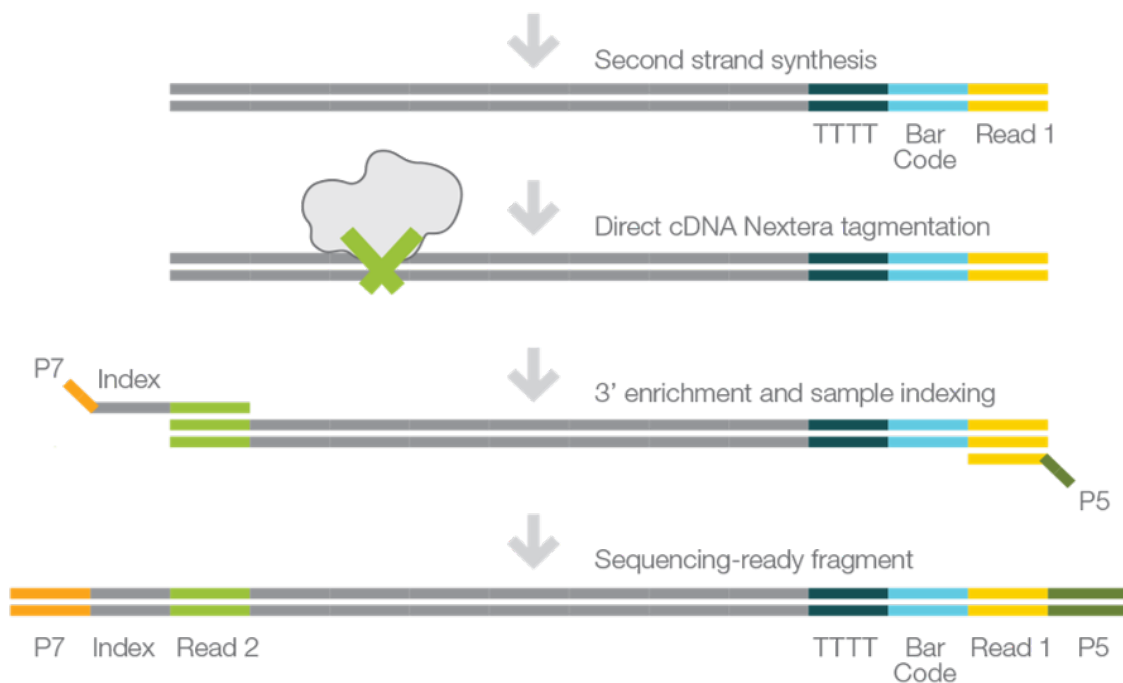

Cell Counting Protocol

Follow these steps to perform cell counting on PBMC.

Assess concentration and viability of the PBMC suspension after the washes and final resuspension in PBS+0.1% as described in *Prepare, Count, and Assess Viability of Single-Cell Suspension* on page 8.

- 1 Perform cell viability measurement as follows:
 - a Vortex the cell suspension tube for a few seconds.
 - b Use a P20 pipette to take 10 μ l from the middle of the cell suspension, and then add 10 μ l of trypan blue 0.4%.
 - c Pipette 10 times to mix, then load onto Chamber A of the Bio-Rad TC20 counting slides.
 - d Measure the cell viability (should be \geq 80%).



NOTE

Make sure the cell suspension is stored on ice at all times.

- 2 Perform cell concentration measurement as follows:
 - a Vortex the cell tube for a few seconds.
 - b Use a P20 pipette to take 10 μ l from the middle of the cell suspension, and immediately load it onto Chamber B of the TC20 chip.
 - c Measure the cell counts in Chamber B on the TC20. This step should be performed without adding trypan blue.
 - d Vortex the cell tube for a few seconds.
 - e Use a P20 pipette to take 10 μ l from the middle of the cell suspension and immediately load it onto Chamber A of the TC20 chip.
 - f Take another 10 μ l from the middle of the cell suspension and immediately load it onto Chamber B of the TC20 chip.
 - g Measure the cell counts in Chamber A and B on the TC20. This step should be performed without adding trypan blue.



NOTE

Make sure the cell suspension is stored on ice at all times.

- 3 Calculate the average cell concentration with the three measurements performed in step 2 to arrive at an accurate cell count.
- 4 Check the average cell concentration. Dilute or concentrate the cell suspension if cells are above or below the target range of 3000 cells/ μ l (do not go under 2500 cells/ μ l). Use cold PBS + 0.1% BSA to dilute or resuspend.
- 5 Proceed to *Prepare Cell and Barcode Suspension Mixes* on page 9. Store cell suspension on ice with preparing reagent.

Lab Tracking Chart

Record lab tracking information and sample observations throughout the protocol. The following template can be used to record process control results such as cDNA yield and final library yield.

Have this information available when contacting Illumina Technical Support. In addition to the observation form, record the following information if you have unexpected results.

- ▶ A detailed description of the problem
- ▶ The steps that were performed immediately before the problem occurred
- ▶ The expected results
- ▶ The observed results

Lab Tracking ID	Step: Cell Preparation	Cell Samples							
		Sample 1	Sample 2	Sample 3	Sample 4				
1	Cell Viability (%)								
2	Cell concentration (cell / μ l)								
Step: After Droplet Generation		Cartridge ports							
		1a	1b	2a	2b	3a	3b	4a	4b
4	Visibly cloudy droplets observed in output wells after single-cell isolation (Yes/No)								
5	Both oil and aqueous layers visible in PCR plate (Yes/No)								
Step: After cDNA synthesis		cDNA library							
		Sample 1	Sample 2	Sample 3	Sample 4				
6	Average cDNA fragment size (bp)								
7	cDNA yield (ng)								
Step: Final library QC		Final library samples							
		Sample 1	Sample 2	Sample 3	Sample 4				
8	Average library fragment size (bp)								
9	Total library yield (nM)								

Acronyms

Acronym	Definition
BSA	Bovine Serum Albumin
PBS	Phosphate-Buffered Saline
RSB	Resuspension Buffer
RTE	Reverse Transcription Enzyme
SPB	(Sample) Purification Beads
SSB	Second Strand Buffer
SSE	Second Strand Enzyme
TCB	Tagment Buffer
TCE	Tagment Enzyme
TPM	Tagmentation PCR Mix
TPP1	Tagment PCR Adapter
TSB	Tagment Stop Buffer

Kit Options

Make sure that you have all the reagents identified in this section before proceeding to the library preparation procedures. Kits are available in the following configurations.

Consumable	Catalog #
SureCell WTA 3' Library Prep Kit for the ddSEQ System (1 Library Prep, 8 Samples)	20014279
SureCell WTA 3' Library Prep Kit for the ddSEQ System (1 Library Prep, 24 Samples)	20014280



NOTE

Certain components of the kit are stored at a temperature that differs from the shipping temperature. Store kit components at the specified temperature.



CAUTION

The SureCell WTA 3' includes Sequencing Primer (SP). Include the Sequencing Primer (SP) with the library when sending to an outside lab for sequencing.

SureCell WTA 3' Library Prep Kit for the ddSEQ System - 8 samples

Box 1

Quantity	Description
2	ddSEQ Cartridges

Box 2—Store at 2°C to 8°C

Quantity	Reagent	Acronym
1	Encapsulation Oil	N/A
1	3' Barcode Mix (Blue Cap)	N/A
1	Droplet Disruptor	N/A
1	Resuspension Buffer	RSB
2	Purification Beads	SPB
1	Tagment Stop Buffer	N/A
1	ddSEQ Priming Solution	N/A

Box 3—Store at -25°C to -15°C

Quantity	Reagent	Acronym
1	Barcode Buffer (Blue Cap)	N/A
1	Cell Suspend Buffer (Red Cap)	N/A
1	RNA Stabilizer (Red Cap)	N/A
1	DTT (Red Cap)	N/A
1	Enzyme Enhancer	N/A
1	RT Enzyme (Red Cap)	RTE
1	Second Strand Buffer	SSB
1	Second Strand Enzyme	SSE
1	Tagment Buffer	TCB
1	Tagment Enzyme	TCE
1	Tagmentation PCR Mix	TPM
1	Tagment PCR Adapter	TPP1
1	Sequencing Primer	SP

Box 4—Store at -25°C to -15°C

Quantity	Reagent	Acronym
8	DNA Adapters	N701–N707, N718

SureCell WTA 3' Library Prep Kit for the ddSEQ System - 24 Samples

Box 1 (Quantity 3)

Quantity	Description
2	ddSEQ M Cartridges

Box 2 (Quantity 3) – Store at 2°C to 8°C

Quantity	Reagent	Acronym
1	Encapsulation Oil	N/A
1	3' Barcode Mix	N/A
1	Droplet Disruptor	N/A
1	Resuspension Buffer	RSB
2	Purification Beads	SPB
1	Tagment Stop Buffer	TSB
1	ddSEQ Priming Solution	N/A

Box 3 (Quantity 3) – Store at -25°C to -15°C

Quantity	Reagent	Acronym
1	Barcode Buffer (Blue Cap)	N/A
1	Cell Suspend Buffer (Red Cap)	N/A
1	RNA Stabilizer (Red Cap)	N/A
1	DTT (Red Cap)	N/A
1	Enzyme Enhancer	N/A
1	RT Enzyme (Red Cap)	RTE
1	Second Strand Buffer	SSB
1	Second Strand Enzyme	SSE
1	Tagment Buffer	TCB
1	Tagment Enzyme	TCE
1	Tagmentation PCR Mix	TPM
1	Tagment PCR Adapter	TPP1

Box 4 – Store at -25°C to -15°C

Quantity	Reagent	Acronym
24	DNA Adapters	N701–N707, N710–N712, N714–N716, N718–N724, N726–N729

Consumables and Equipment

Make sure that you have the required user-supplied consumables and equipment before starting the protocol.

The protocol has been optimized and validated using the items listed. Comparable performance is not guaranteed when using alternate consumables and equipment.



NOTE

- Use a dedicated set of consumables and equipment for pre-PCR and post-PCR procedures.
- The SureCell WTA 3' library prep protocol requires different magnetic stands during library clean-up procedures.

Consumables

Consumable	Supplier
20 µl racked pipette tips	Rainin, item # 17002928
20 µl multichannel pipettes	Rainin, item # 17013803
20 µl single channel pipettes	Rainin, item # 17014392
50 µl multichannel pipettes	Rainin, item # 17013804
200 µl racked pipette tips	Rainin, item # 17002428
200 µl multichannel pipettes	Rainin, item # 17013805
200 µl single channel pipettes	Rainin, item # 17014391
Cell strainer 35 µm (500/case)	Coming Life Sciences, product #352235
Ethanol 200 proof (absolute) for molecular biology (500 ml)	Sigma-Aldrich, product # E7023
Nuclease-free water	General lab supplier
Bio-Rad ddPCR Plate	Bio-Rad, catalog # 12001925
TC20 slides	Bio-Rad, catalog # 145003
Trypan blue	Bio-Rad, catalog # 1450021
8-tube strip	General lab supplier
Flat cap strips	Bio-Rad, catalog # TCS-0803
Multichannel pipette reservoir	General lab supplier

Equipment

Equipment	Supplier
ddSEQ Single-Cell Isolator	Bio-Rad, catalog # 12004336
One of the following 96-well thermal cyclers: <ul style="list-style-type: none"> • T100 Thermal Cycler • C1000 Touch Thermal Cycler 	Bio-Rad, catalog # 1861096 Bio-Rad, catalog # 1851197
TC20 automated cell counter	Bio-Rad, catalog # 145-0102
Magnetic peg stand-96	Thermo Fisher, catalog # AM10027
DynaMag-96 side magnet DynaMaga-96 side skirted magnet	Thermo Fisher, catalog # 12331D Thermo Fisher, catalog # 12027
Microplate centrifuge	Eppendorf, catalog # 5804 Eppendorf, catalog # 5430
Vortexer	General lab supplier

Technical Assistance

For technical assistance, contact Illumina Technical Support.

Website: www.illumina.com
Email: techsupport@illumina.com

Illumina Customer Support Telephone Numbers

Region	Toll Free	Regional
North America	+1.800.809.4566	
Australia	+1.800.775.688	
Austria	+43 800006249	+43 19286540
Belgium	+32 80077160	+32 34002973
China	400.066.5835	
Denmark	+45 80820183	+45 89871156
Finland	+358 800918363	+358 974790110
France	+33 805102193	+33 170770446
Germany	+49 8001014940	+49 8938035677
Hong Kong	800960230	
Ireland	+353 1800936608	+353 016950506
Italy	+39 800985513	+39 236003759
Japan	0800.111.5011	
Netherlands	+31 8000222493	+31 207132960
New Zealand	0800.451.650	
Norway	+47 800 16836	+47 21939693
Singapore	+1.800.579.2745	
Spain	+34 911899417	+34 800300143
Sweden	+46 850619671	+46 200883979
Switzerland	+41 565800000	+41 800200442
Taiwan	00806651752	
United Kingdom	+44 8000126019	+44 2073057197
Other countries	+44.1799.534000	

Safety data sheets (SDSs)—Available on the Illumina website at support.illumina.com/sds.html.

Product documentation—Available for download in PDF from the Illumina website. Go to support.illumina.com, select a product, then select **Documentation & Literature**.



Illumina

5200 Illumina Way

San Diego, California 92122 U.S.A.

+1.800.809.ILMN (4566)

+1.858.202.4566 (outside North America)

techsupport@illumina.com

www.illumina.com

For Research Use Only. Not for use in diagnostic procedures.

© 2017 Illumina, Inc. All rights reserved.

illumina[®]